

Central-Snap Condition Details

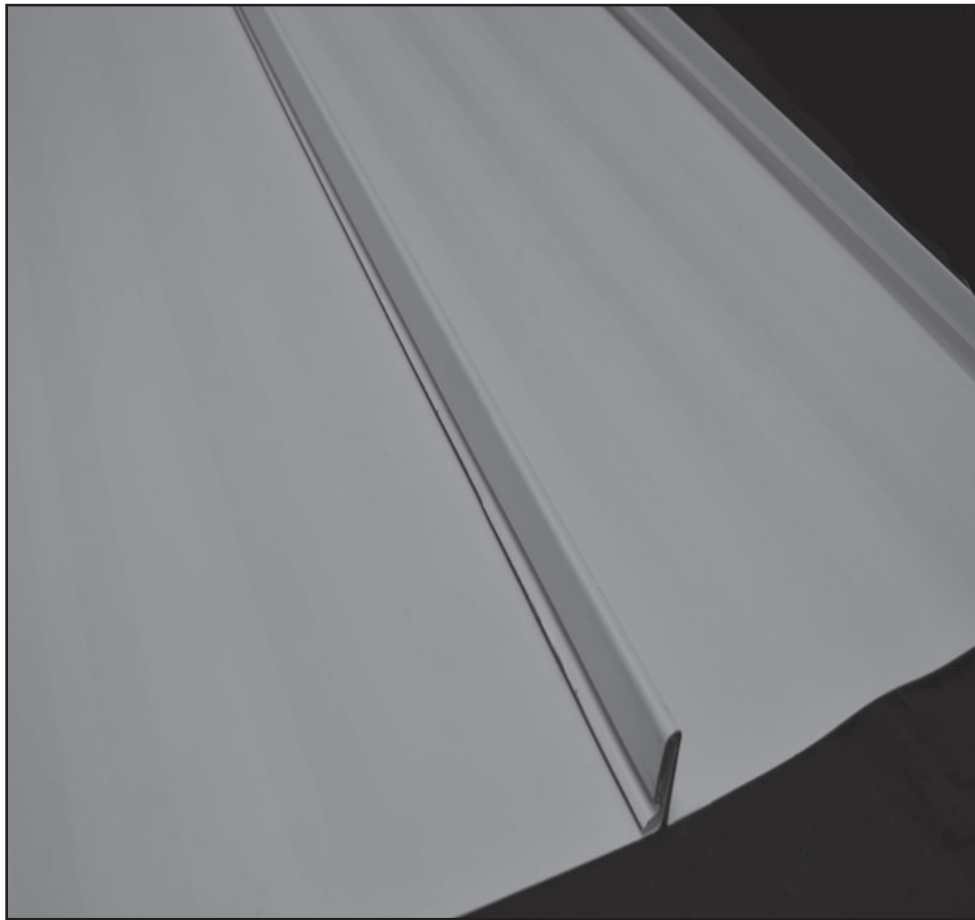

**CENTRAL
STATES**

MANUFACTURING, INC.
METAL BUILDING COMPONENTS
WWW.CENTRALSTATESMFG.COM



Central-Snap

Vertical 1³/₄"

Standing Seam Roof Panel

Installation is a Snap with **Central-Snap** from



Central States offers a vertical 1³/₄" snap-lock standing seam panel system that is sturdy and fire resistant, making it ideal for architectural and commercial applications. Its Galvalume substrate offers two to four times the corrosion resistance of galvanized steel.

Comprehensive condition details are available and come attached to each order. Central States also carries an extensive line of standing seam trims and accessories to complement this panel.

Standing Seam Roofing Features:

- Subtle striations between ribs on 16" and wider panels reduce the appearance of oil-canning.
- Available in 24 gauge in 17 standard colors in the Kynar® (polyvinylidene fluoride) coating system.
- Tested in accordance with UL580 & ASTM E1592.
- Meets UL 90 wind uplift requirement for all panel widths offered.
- Should be installed over solid substrates but can be installed over open framing depending upon the panel width and support member spans.
- Available with a 1-1/8" notch at one or both ends of each panel for the ease of turning under; reducing installation labor and costs.
- Factory applied hot melt sealant is standard.
- Snap-together panel, no field seaming required.
- Recommended minimum slope of 3:12.

CENTRAL - SNAP

GABLE DETAIL

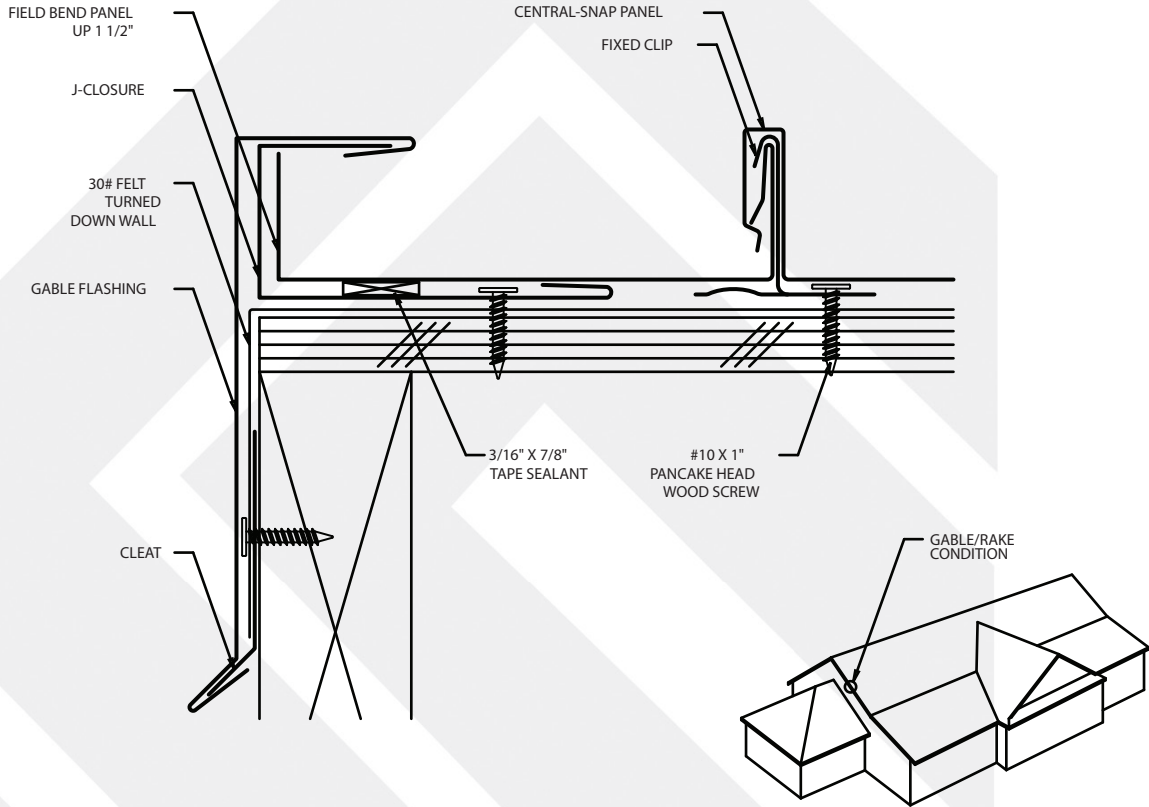

FLASHING COMPONENTS

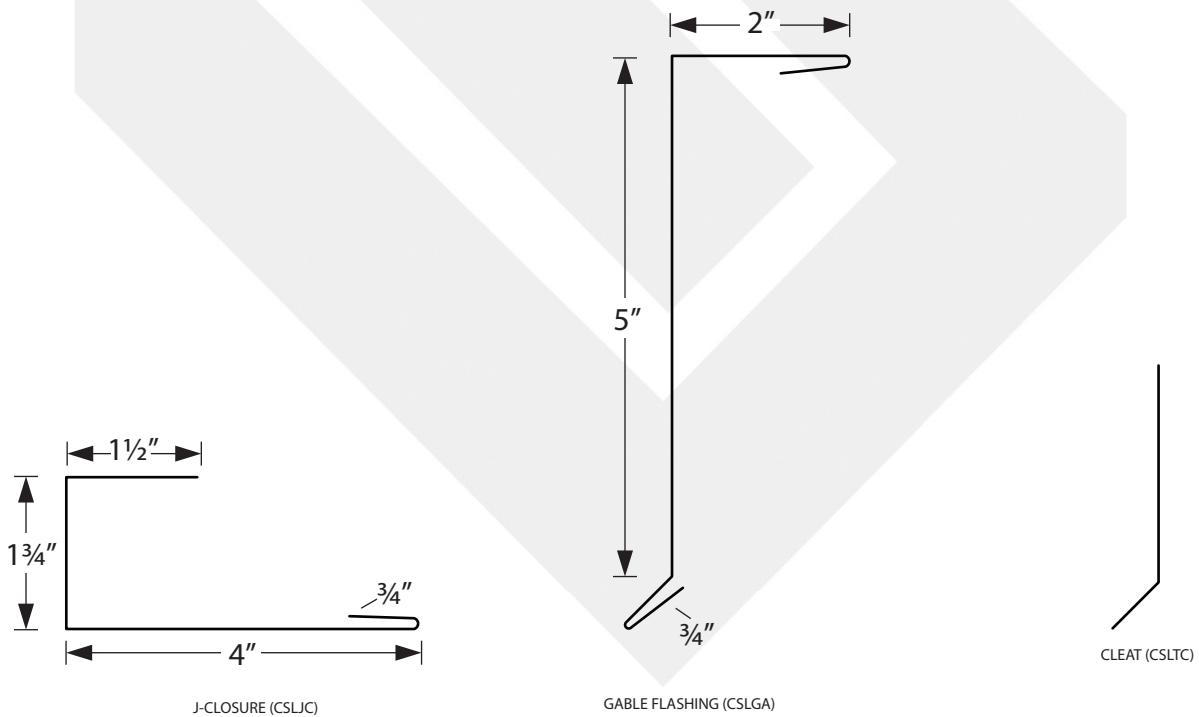

CENTRAL - SNAP

ALTERNATE GABLE DETAIL

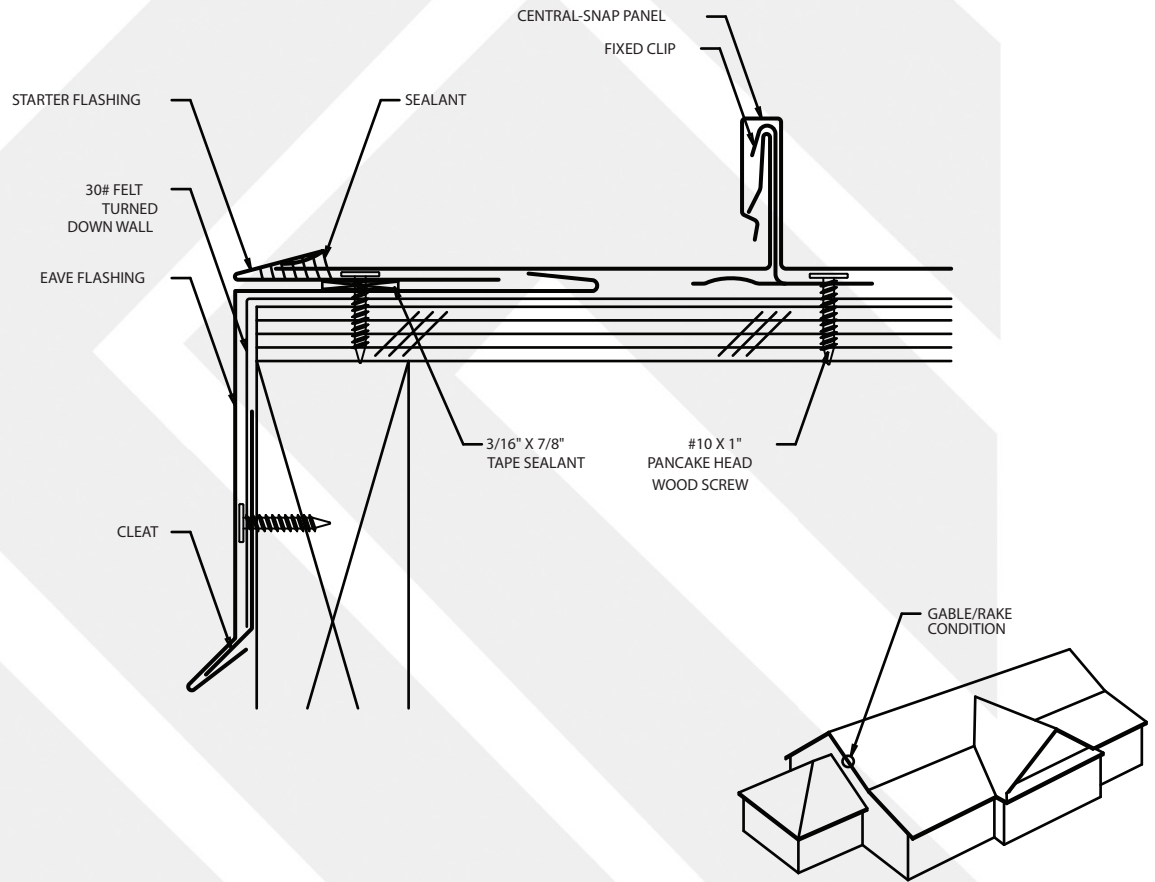

FLASHING COMPONENTS

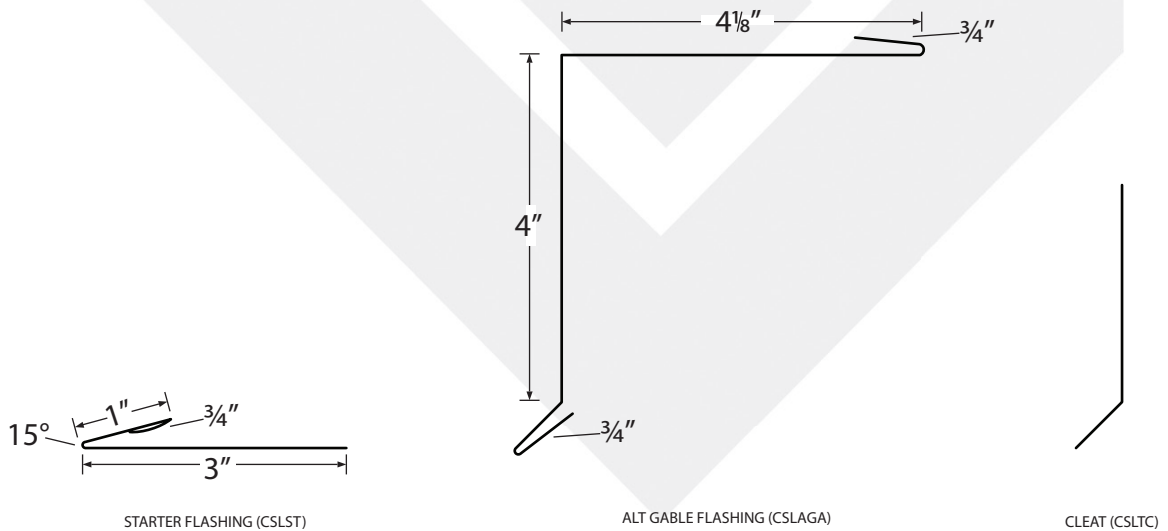

CENTRAL - SNAP

ENDWALL DETAIL

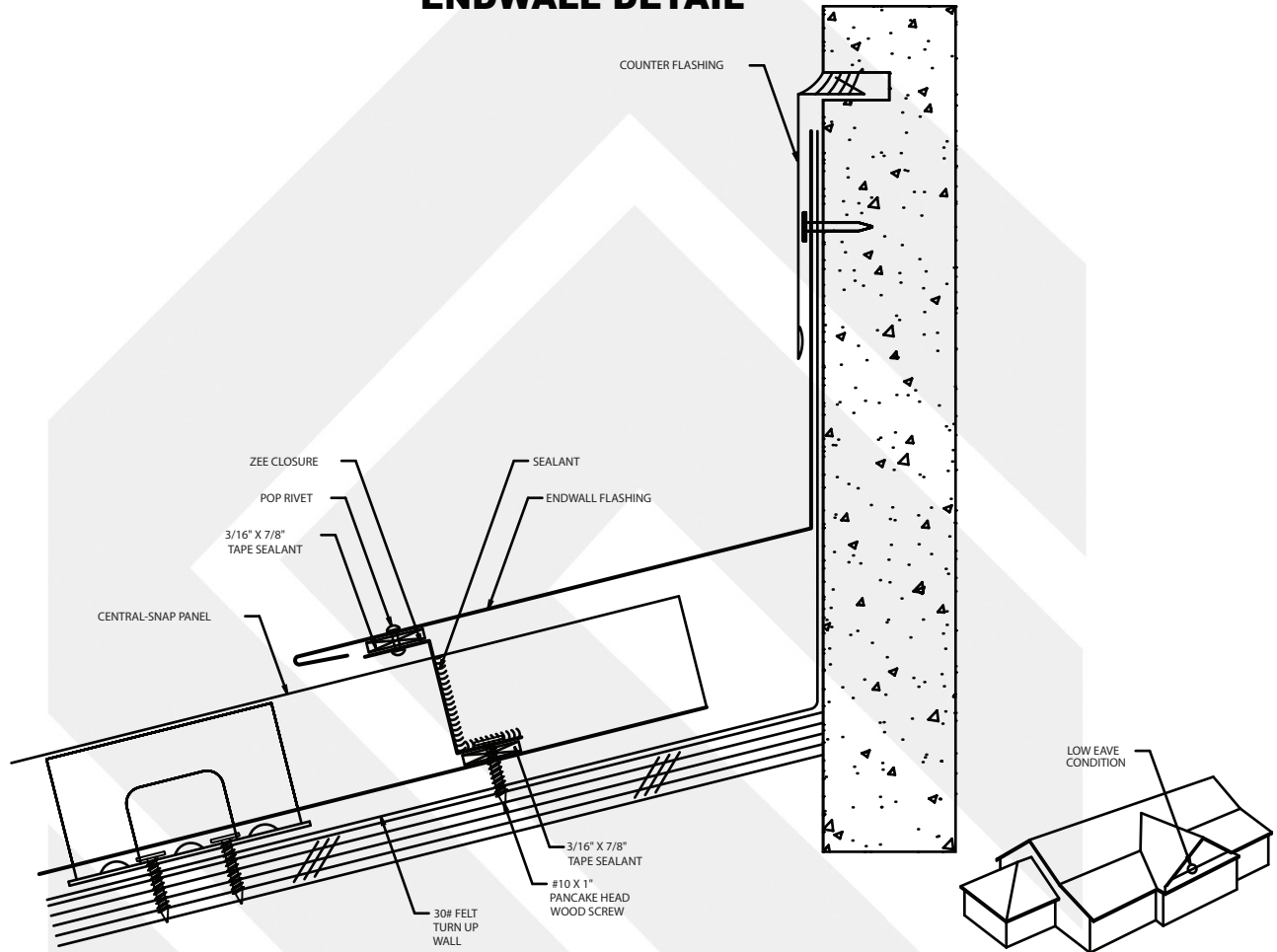

FLASHING COMPONENTS

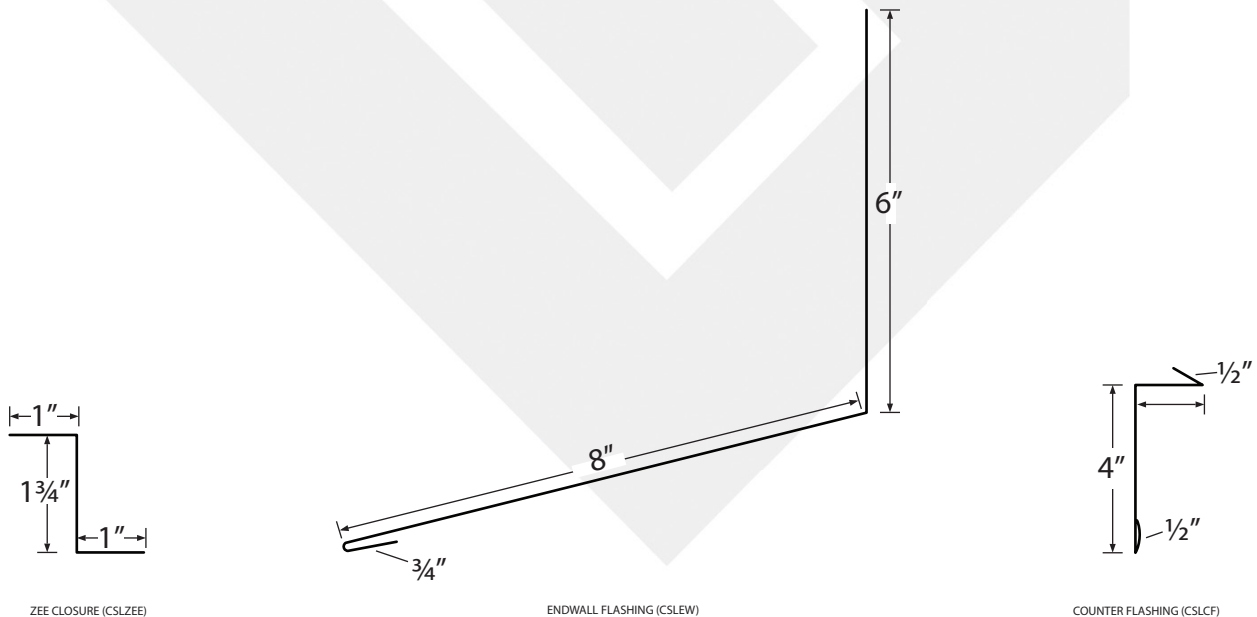

ZEE CLOSURE (CSLZEE)

ENDWALL FLASHING (CSLEW)

COUNTER FLASHING (CSLCF)

CENTRAL - SNAP

SIDEWALL DETAIL

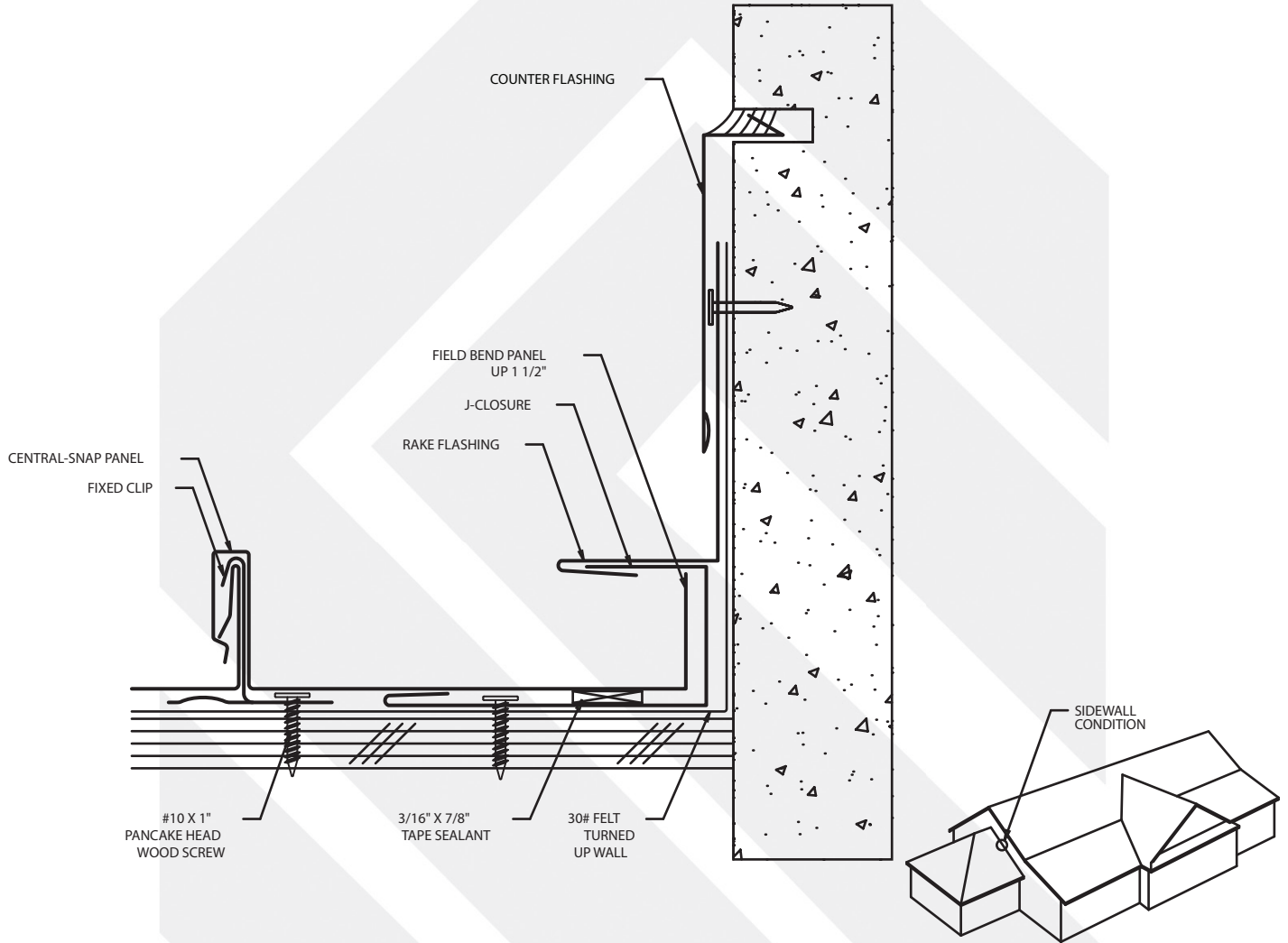

FLASHING COMPONENTS

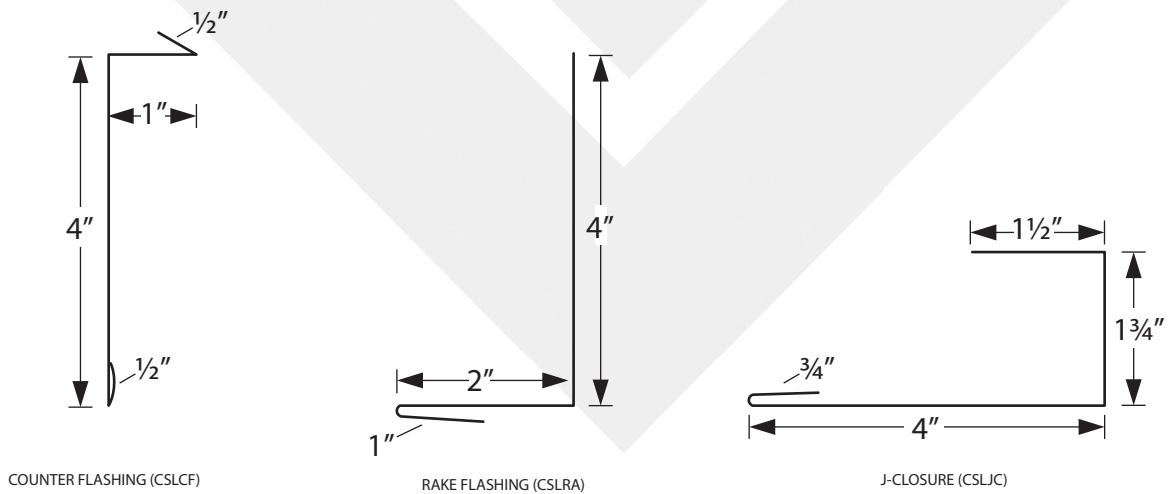

CENTRAL - SNAP GUTTER DETAIL

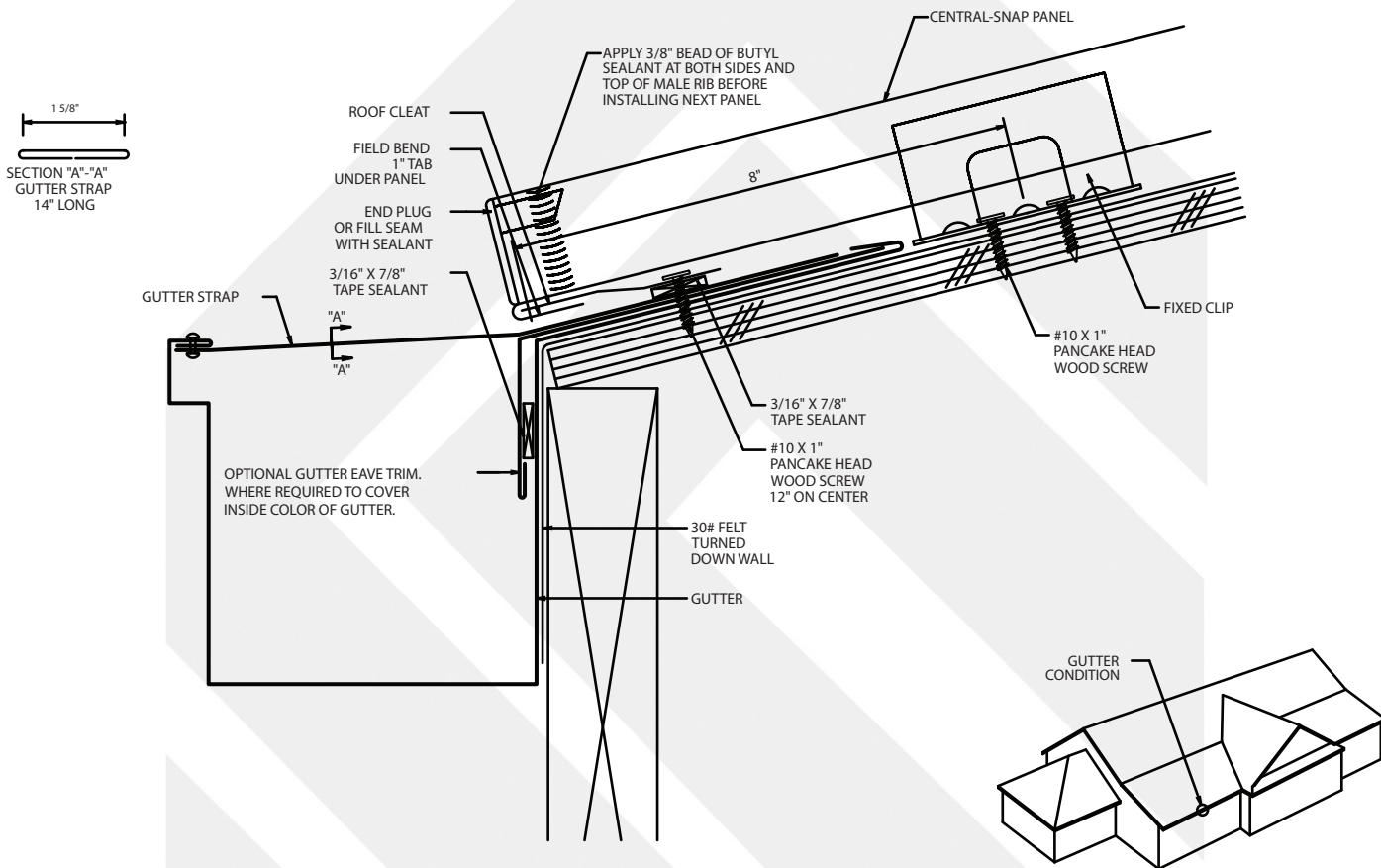

FLASHING COMPONENTS

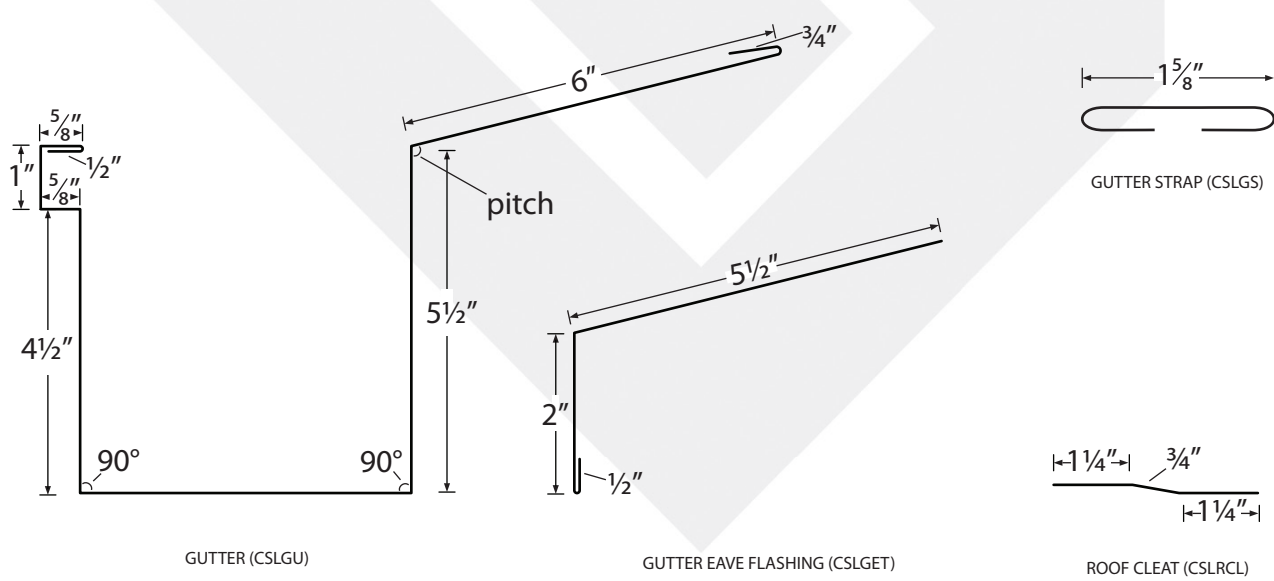

CENTRAL - SNAP

EAVE DETAIL

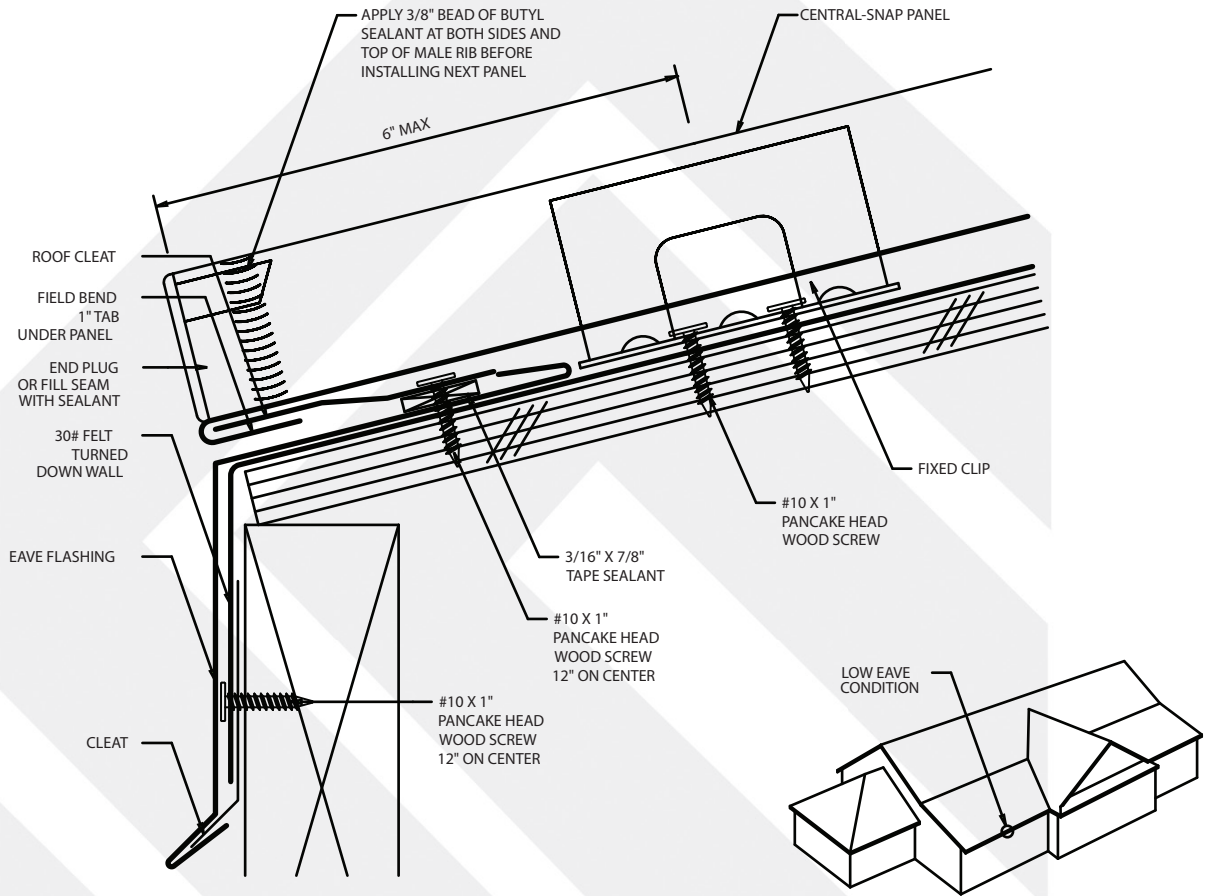

FLASHING COMPONENTS

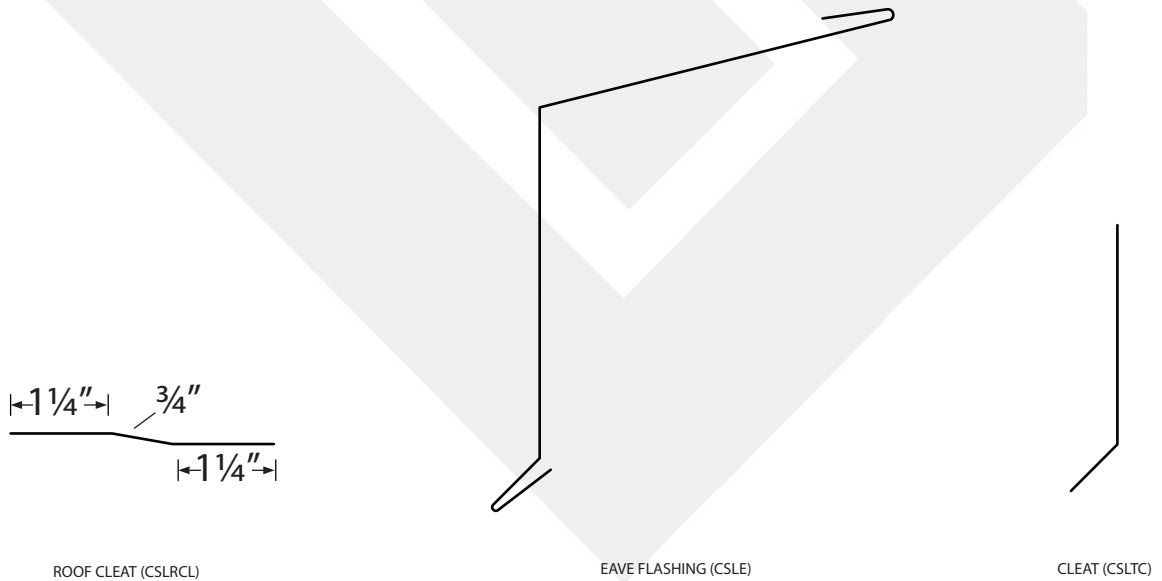

CENTRAL - SNAP

VALLEY DETAIL

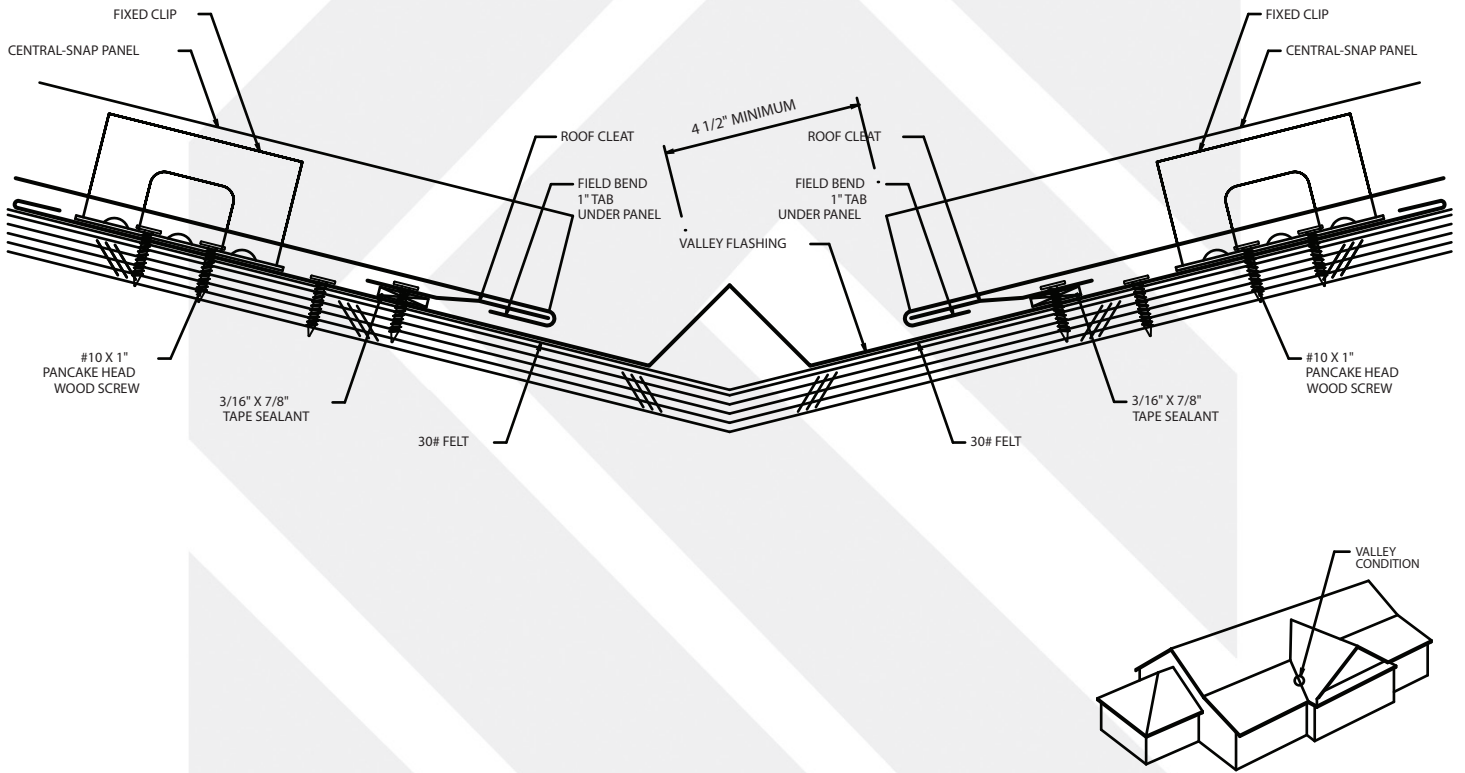

FLASHING COMPONENTS

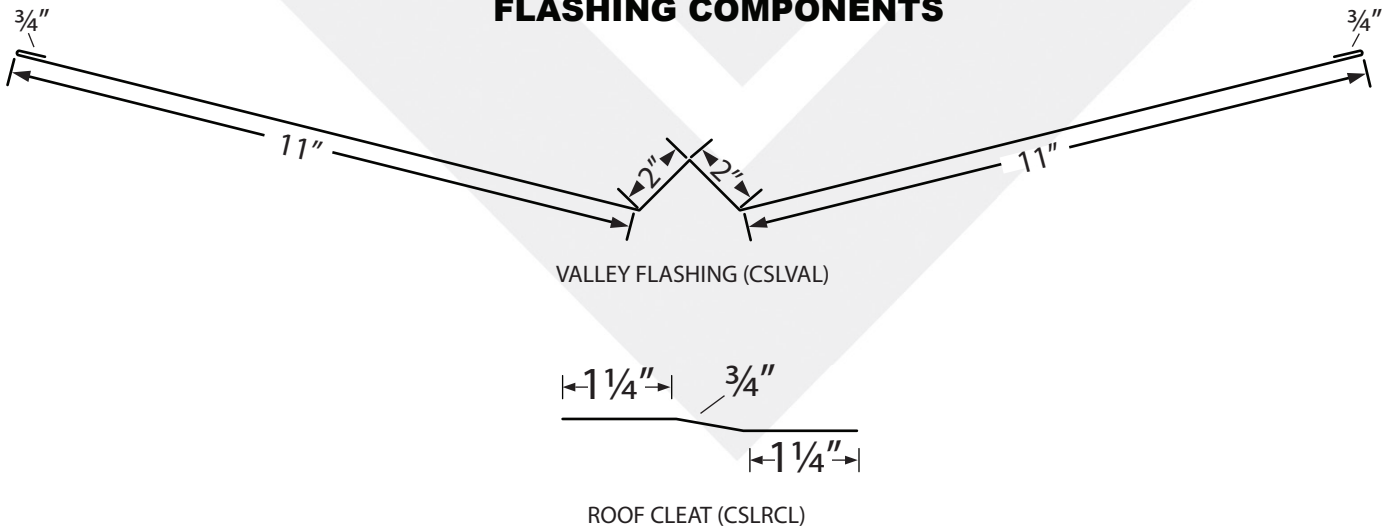

CENTRAL - SNAP

HIP / RIDGE DETAIL

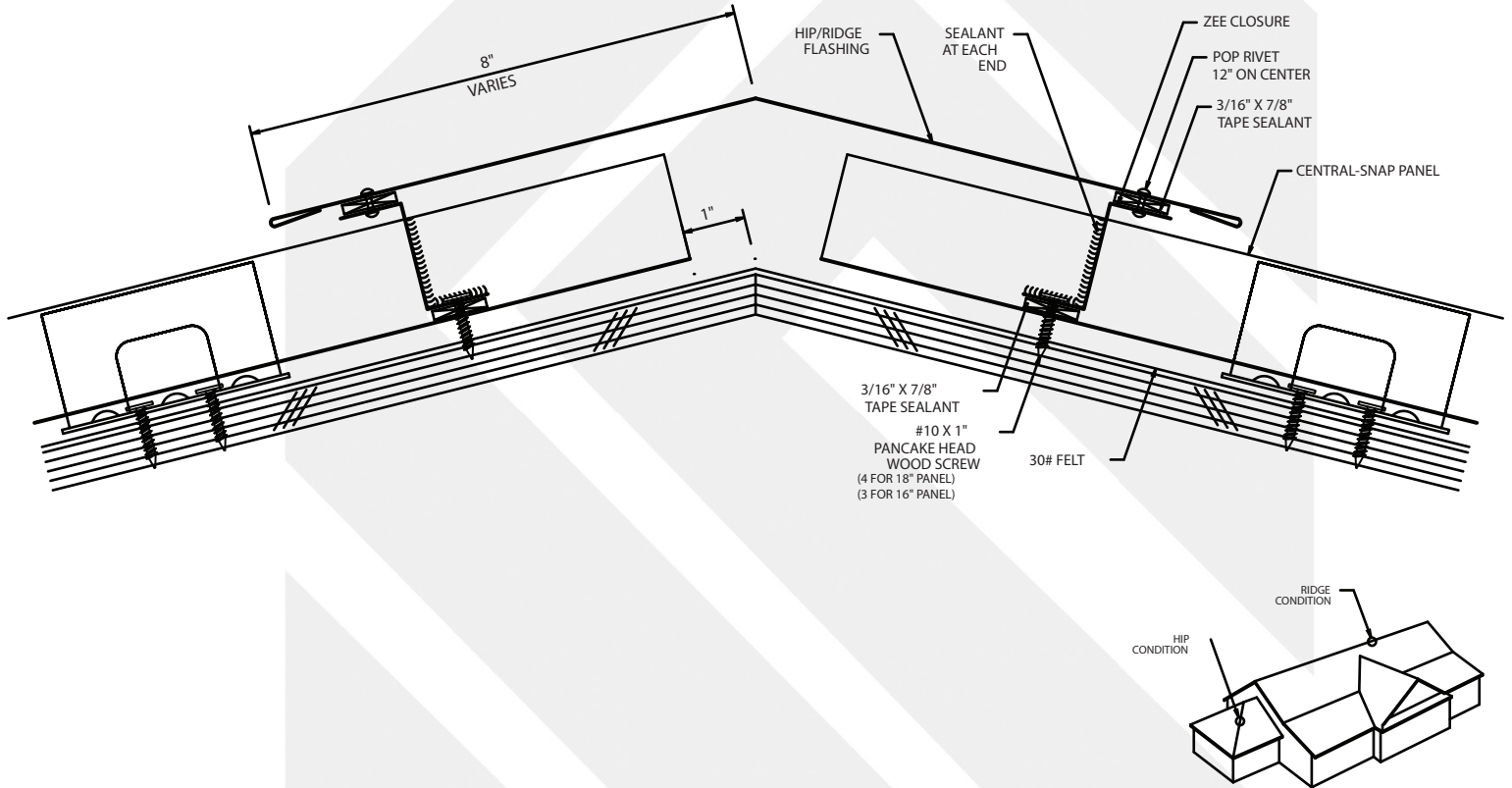

FLASHING COMPONENTS

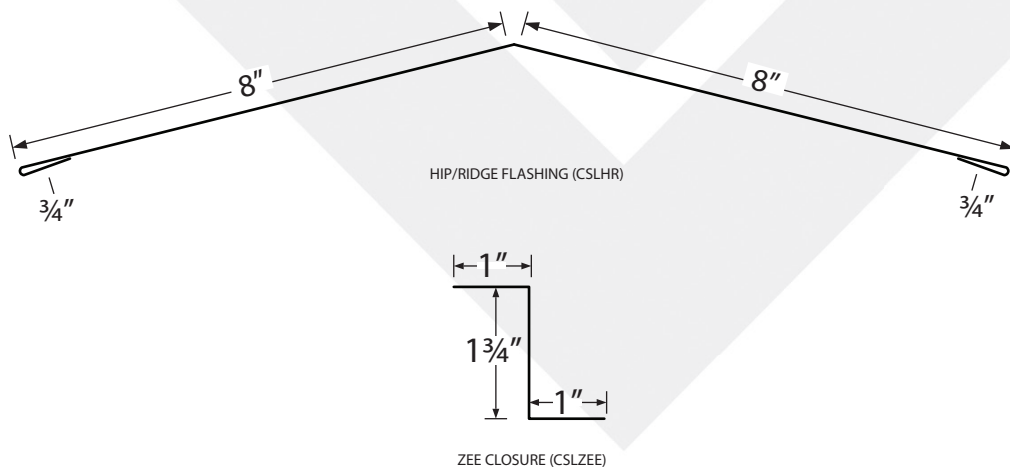

CENTRAL - SNAP

PITCH TRANSITION DETAIL

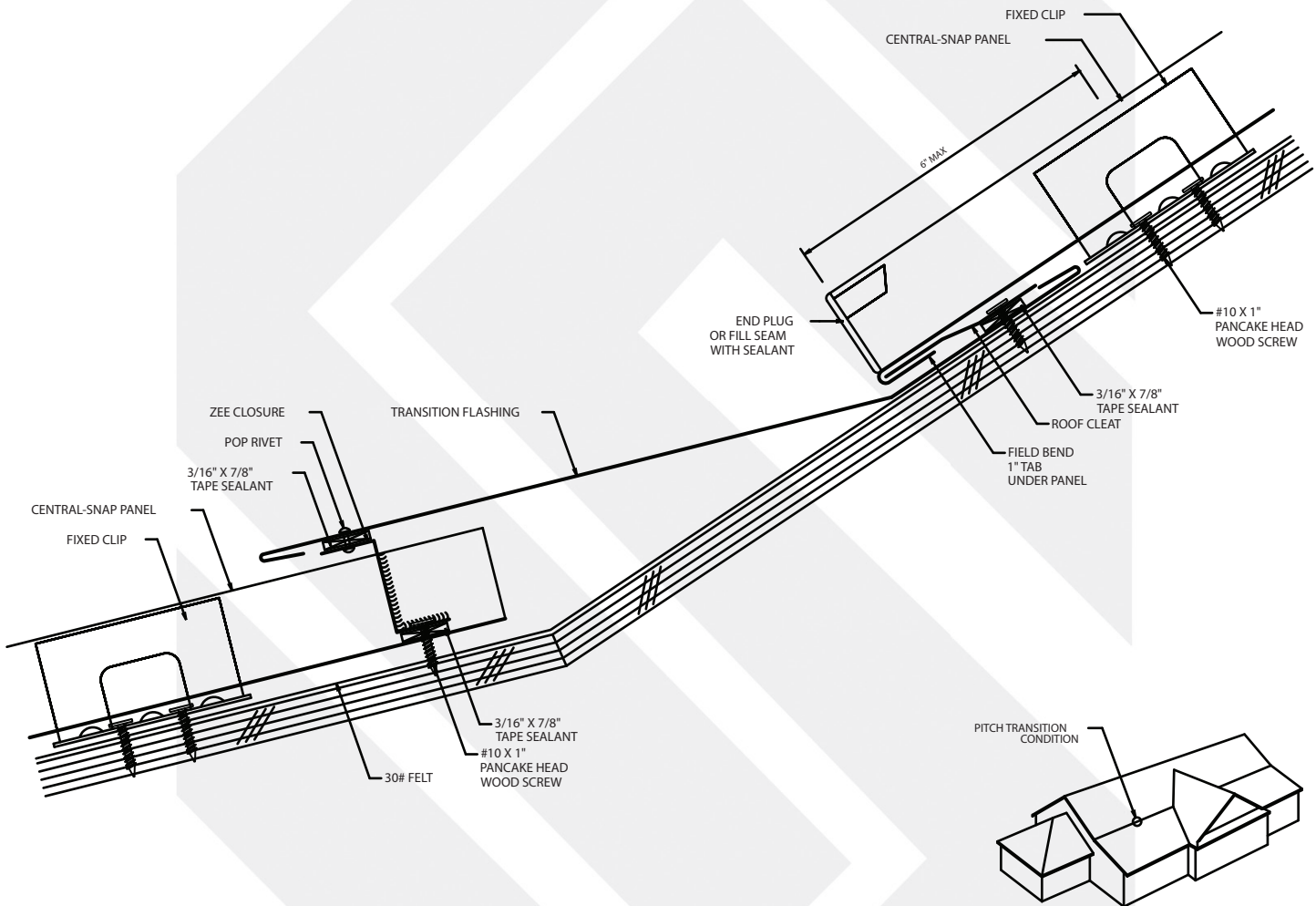

FLASHING COMPONENTS

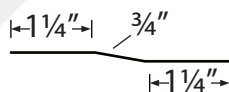
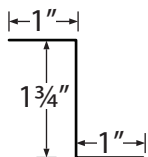
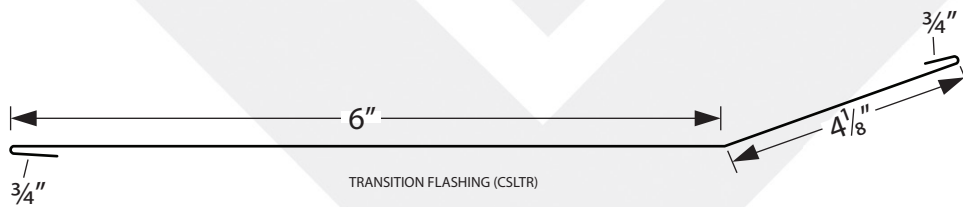

ZEE CLOSURE (CSLZEE)

ROOF CLEAT (CSLRCL)

CENTRAL - SNAP

PANEL NOTCH

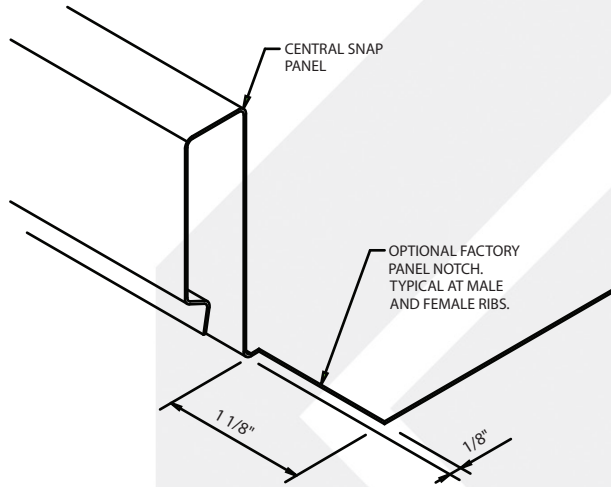

LAP SEAL

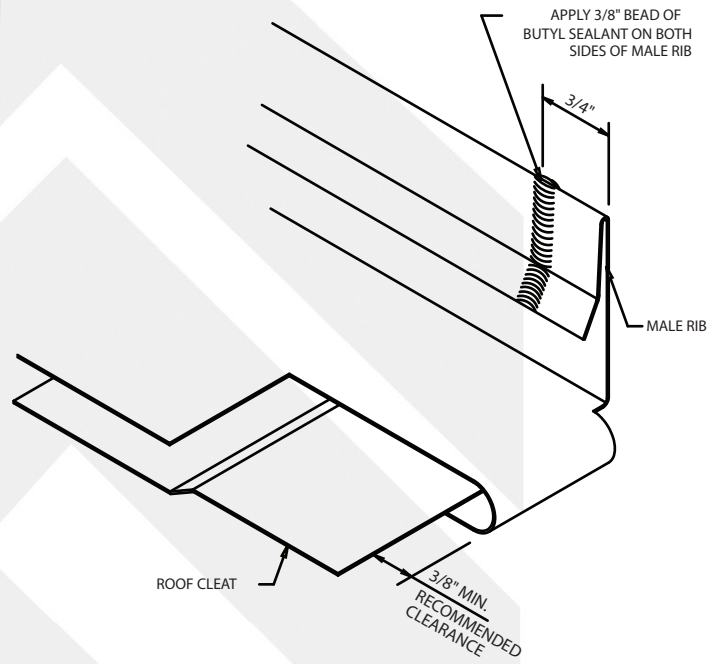

PANEL HEM

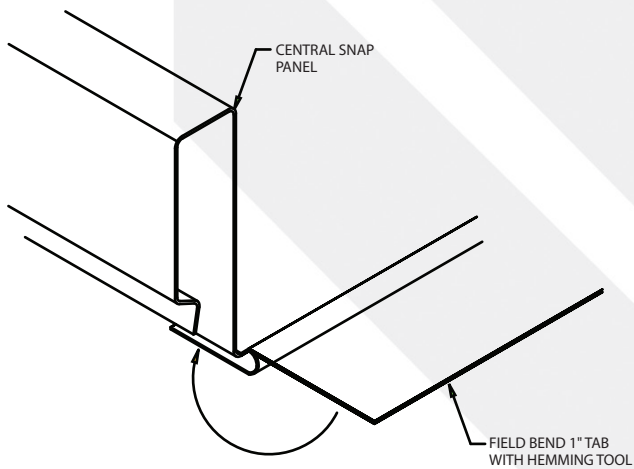

CENTRAL - SNAP

UL 90 CLIP

Part Code: CSLCLP

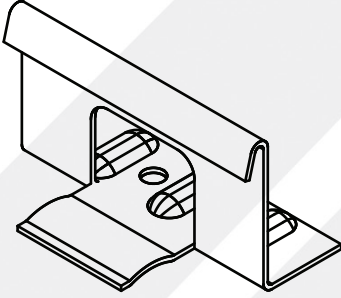

TUBE SEALANT

Part Code: GEOC
GEOG
GEOW

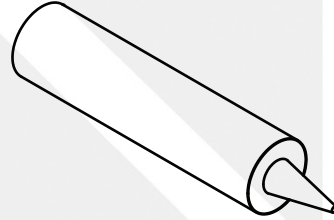

FASTENER- METAL

Part Code: 12FASTENER
#12-10 X 1 Pan Head



FASTENER- WOOD

Part Code: CSLWFAST
#10-9 X 1 Wood



TAPE SEALANT

Part Code: BTR
3/16" x 7/8"x40'

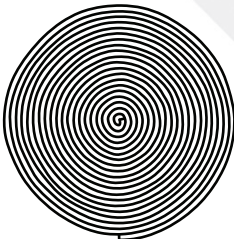

POP RIVETS

Part Code: POP(color)
1/8" Pop Rivet



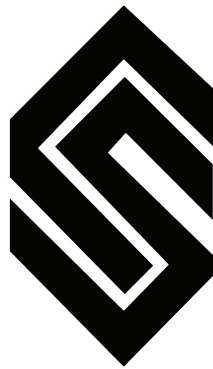

CENTRAL STATES

**MANUFACTURING, INC.
METAL BUILDING COMPONENTS
WWW.CENTRALSTATESMFG.COM**

302 Jane Place
Lowell, AR 72745
800-356-2733

2051 Tryon Road
Michigan City, IN 46360
800-638-2565

660 Grigsby Way
Cedar Hill, TX 75104
800-210-8305

3402 Industrial Drive
Jasper, AL 35501
866-270-6608

751 Piedmont Triad West Dr.
Mount Airy, NC 27030
877-813-2111